

**We've Got  
the GROOVEX**



## NEW PRODUCT ANNOUNCEMENT



### **NEW!** Face Grooving Now Available from Mini-V

Expanded Mini-V line now includes Square and Round Face Grooving tools for internal and external applications with minimum bore diameters of 12 mm and 14 mm, respectively.

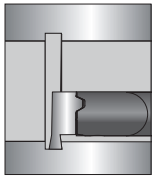
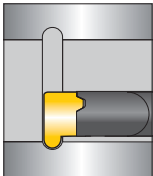
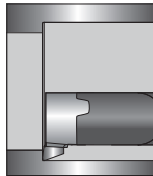
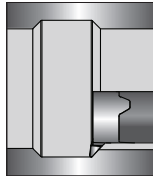
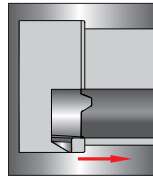
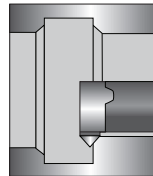
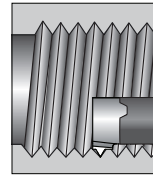

#### The Complete Range of Mini-V Solutions for Small & Medium Bores

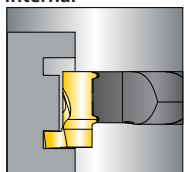
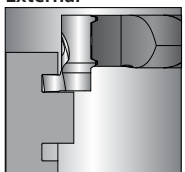
|  |   |   |   |  |   |   |
|--|---|---|---|--|---|---|
|  |  |  |  |  |  |  |
| Grooving   | Grooving - Round Partial  | Boring  | Copy Long Nose  | Back Boring  | Chamfering  | Threading   |

**NEW** Face Grooving Square

|  |   |   |
|--|---|---|
|  |  |  |
| Internal   | External  |   |

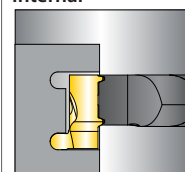
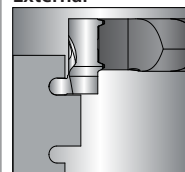
**NEW** Face Grooving Round

|  |   |   |
|--|---|---|
|  |  |  |
| Internal   | External  |   |

**Face Grooving Square Internal**



| Insert Style | Item Number | Ordering Code      | Dimensions (mm) |     |     |      |   |     | Min. Bore dia. |          | Toolholder |
|--------------|-------------|--------------------|-----------------|-----|-----|------|---|-----|----------------|----------|------------|
|              |             | RH                 | d               | W   | t1  | T    | F | r   | D min          |          |            |
| V-14         | 046-00219   | V14FGW100T150 R... | 9               | 1.0 | 1.5 | 7.7  | 9 | 0.2 | 14.0           | .V14-... |            |
|              | 046-00221   | V14FGW150T250 R... |                 | 1.5 | 2.5 | 8.7  |   |     |                |          |            |
|              | 046-00223   | V14FGW200T300 R... |                 | 2.0 | 3.0 | 9.2  |   |     |                |          |            |
|              | 046-00224   | V14FGW200T500 R... |                 | 2.0 | 5.0 | 10.7 |   |     |                |          |            |
|              | 046-00225   | V14FGW250T300 R... |                 | 2.5 | 3.0 | 9.2  |   |     |                |          |            |
|              | 046-00226   | V14FGW250T500 R... |                 | 2.5 | 5.0 | 10.7 |   |     |                |          |            |
|              | 046-00227   | V14FGW300T300 R... |                 | 3.0 | 3.0 | 9.2  |   |     |                |          |            |

**Face Grooving Square External**



| Insert Style | Item Number | Ordering Code       | Dimensions (mm) |     |     |      |   |     | Min. Bore dia. |          | Toolholder |
|--------------|-------------|---------------------|-----------------|-----|-----|------|---|-----|----------------|----------|------------|
|              |             | RH                  | d               | W   | t1  | T    | F | r   | D min          |          |            |
| V-14         | 046-00230   | V14FEGW100T150 R... | 9               | 1.0 | 1.5 | 7.3  | 9 | 0.2 | 14.0           | .V14-... |            |
|              | 046-00231   | V14FEGW150T250 R... |                 | 1.5 | 2.5 | 8.3  |   |     |                |          |            |
|              | 046-00232   | V14FEGW200T300 R... |                 | 2.0 | 3.0 | 8.8  |   |     |                |          |            |
|              | 046-00233   | V14FEGW200T500 R... |                 | 2.0 | 5.0 | 10.7 |   |     |                |          |            |
|              | 046-00234   | V14FEGW250T300 R... |                 | 2.5 | 3.0 | 8.8  |   |     |                |          |            |
|              | 046-00235   | V14FEGW250T500 R... |                 | 2.5 | 5.0 | 10.7 |   |     |                |          |            |
|              | 046-00236   | V14FEGW300T300 R... |                 | 3.0 | 3.0 | 8.8  |   |     |                |          |            |

**Face Grooving Round Internal**



| Insert Style | Item Number | Ordering Code      | Dimensions (mm) |     |     |     |     |     |     | Min. Bore dia. | Toolholder |
|--------------|-------------|--------------------|-----------------|-----|-----|-----|-----|-----|-----|----------------|------------|
|              |             |                    | RH              | d   | W   | t1  | T   | F   | r   |                |            |
| V-14         | 046-00218   | V14FGR050T150 R... |                 |     | 1.0 | 1.5 | 7.7 |     | 0.5 | 14.0           | .V14-...   |
|              | 046-00220   | V14FGR100T300 R... | 9               | 2.0 | 3.0 | 9.2 | 9   | 1.0 |     |                |            |
|              | 046-00222   | V14FGR150T300 R... |                 | 3.0 | 3.0 | 9.2 |     | 1.5 |     |                |            |

**Face Grooving Round External**



| Insert Style | Item Number | Ordering Code       | Dimensions (mm) |   |     |     |      |   |      | Min. Bore dia. | Toolholder |
|--------------|-------------|---------------------|-----------------|---|-----|-----|------|---|------|----------------|------------|
|              |             |                     | RH              | d | W   | t1  | T    | F | r    |                |            |
| V-14         | 046-00228   | V14FEGR100T500 R... |                 | 9 | 2.0 | 5.0 | 10.7 | 9 | 1    | 14.0           | .V14-...   |
|              | 046-00229   | V14FEGR125T500 R... |                 |   | 2.5 |     |      |   | 1.25 |                |            |

## Mini-V 14V Toolholders

### Mini-V Toolholders - Reinforced Carbide Shank

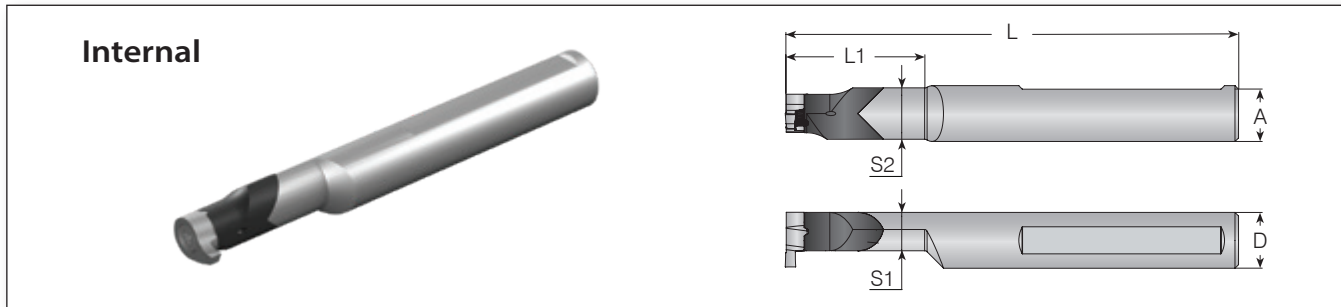

| Insert Style | Item Number | Ordering Code |             | Dimensions mm |     |    |    |     | Spare Parts |           |      |
|--------------|-------------|---------------|-------------|---------------|-----|----|----|-----|-------------|-----------|------|
|              |             | Sleeve        | Holder RH   | A             | L   | L1 | D  | S1  | Screw       | Size      | Key  |
| V14          | 017-00015   | -             | * CV14-1234 | 11            | 100 | 34 | 12 | 9.3 | SNV14       | M4x0.7x12 | KT15 |
|              | 017-00016   | -             | * CV14-1245 |               | 110 | 45 |    |     |             |           |      |
|              | 017-00017   | -             | * CV14-1264 |               | 130 | 64 |    |     |             |           |      |
|              | 017-00045   | -             | * CV14-1634 | 15            | 100 | 34 | 16 | 9.4 |             |           |      |
|              | 017-00046   | -             | * CV14-1645 |               | 110 | 45 |    |     |             |           |      |
|              | 017-00047   | -             | * CV14-1664 |               | 130 | 64 |    |     |             |           |      |
|              | 017-00048   | -             | * CV14-1675 |               | 145 | 75 |    |     |             |           |      |

\* Right hand only, LH by request

### Mini-V Toolholders - Alloy Steel Shank

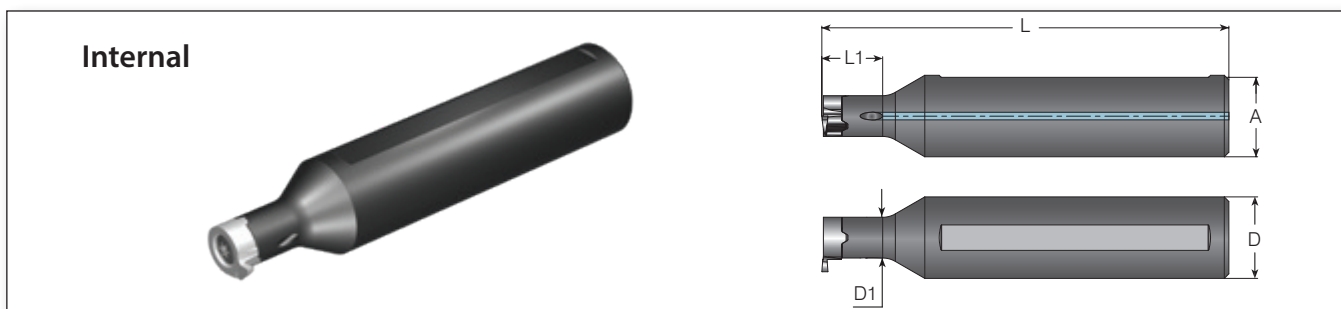

| Insert Style | Item Number | Ordering Code |           | Dimensions mm |     |    |    |    | Spare Parts |           |      |
|--------------|-------------|---------------|-----------|---------------|-----|----|----|----|-------------|-----------|------|
|              |             | Sleeve        | Holder RH | A             | L   | L1 | D  | D1 | Screw       | Size      | Key  |
| V14          | 017-00058   |               | V14-1620  | 15.0          | 100 | 22 | 16 | 11 | SNV14       | M4x0.7x12 | KT15 |

## Ordering Information

Mini-V tools can be ordered from the Groovex Mini-V Catalog.

## Availability

Available in stock from March 1, 2013.

## Prices

Please contact your Customer Service Representative for prices on the items listed herein.

## New Marketing Material

All Mini-V tools are outlined in the **Mini-V** Metric - 221-01175



Visit Groovex Site

Please contact me directly with specific questions and requests.  
For additional updates and news, visit the VARGUS website: [www.vargus.com](http://www.vargus.com)

  
Alex Glick  
GROOVEX Product Manager