



▶ REDLINE

Gamma completa di
inserti spessi per filettare



METRICO



Ampia gamma di inserti per filettare spessi

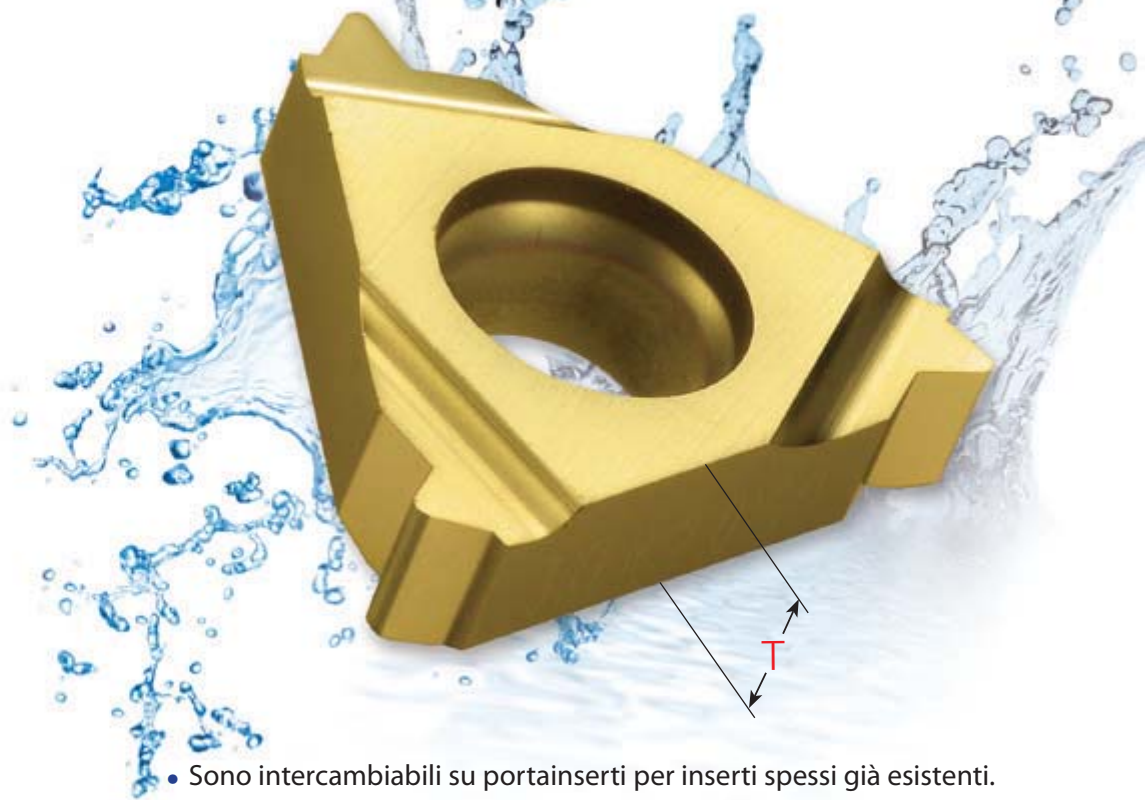

- Sono intercambiabili su portainseriti per inserti spessi già esistenti.
- Non serve cambiare il portainserito.
- Prodotti in VKX, il miglior grado per usi generici



Spessore inserti Redline (T)

I.C.	L (mm)	T - Standard (mm)	T - Redline (mm)
1/4"	11	3.17	3.39
3/8"	16	3.60	4.30
1/2"	22	4.76	5.90

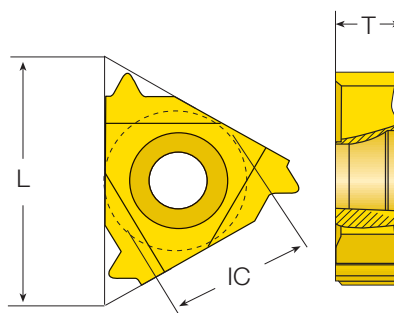

REDLINE CATALOGO

INSERTI

■ Parziale 60°	Pagina 4
■ Parziale 55°	Pagina 4
■ UN Americana	Pagina 5
■ ISO Metrico	Pagina 6
■ Whitworth per BSW, BSP, BSF, BSB	Pagina 7
■ BSPT	Pagina 7
■ NPT	Pagina 8
■ Tondo (DIN 405)	Pagina 8
■ Trapezio	Pagina 9
■ ACME Americana	Pagina 9
■ Stube ACME	Pagina 10
■ UNJ	Pagina 10
■ American Buttress	Pagina 11
■ API	Pagina 11
■ API Buttress Casing	Pagina 12
■ API Round Casing & Tubing	Pagina 12

PORTAINSERTI

■ Esterno	Pagina 13
■ Interno	Pagina 13

DATI TECNICI

■ Angolo dell'elica e selezione del sottopiacchetta	Pagina 14
■ Disegno API Standard	Pagina 15
■ Parametri di taglio	Pagina 16

VARGUS
GENiUS™

Selezione dell'utensile e
Generatore programma CNC



Il più diffuso ed avanzato software di filettatura su tornio e su fresa attualmente sul mercato.

Da oggi disponibile in 2 versioni su: www.vargus.com

- Versione Online
 - Versione Online interattiva
 - Utilizzabile da tutti i browser più diffusi
 - Le versioni aggiornate sono sempre online
- Versione Desktop (scaricabile sul pc)
 - Software indipendente
 - Programma basato su tecnologia MS Windows
 - Aggiornamenti automatici

Parziale 60°

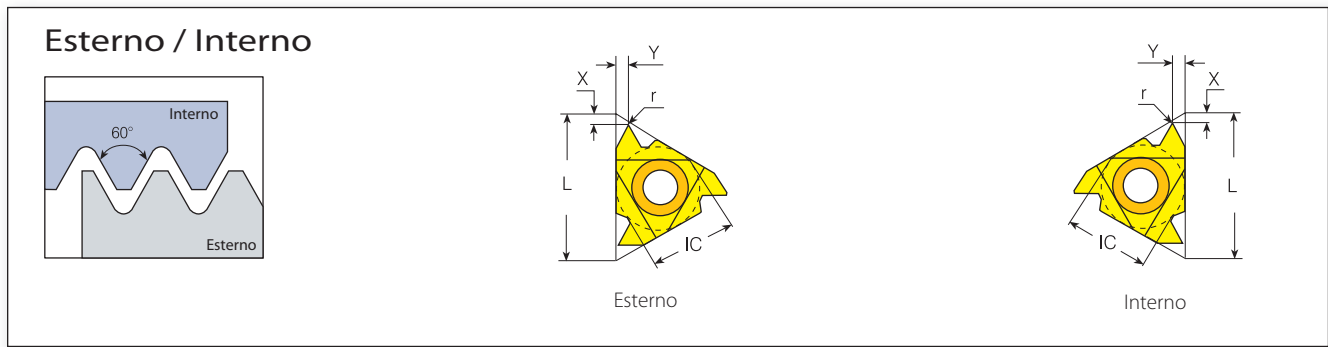

	Dim. Inserto		Passo		Codice	Dimensioni (mm)			Sottoplacchetta				
	IC	L mm	mm	tpi	RH	r	X	Y	RH	Portainseriti			
	Esterno	3/8"	16	0.5-1.5	48-16	3XERA60...	0.05	1.04	0.99				
				1.75-3.0	14-8	3XERG60...	0.27	1.10	1.65	YE3	AL...-3X		
				0.5-3.0	48-8	3XERAG60...	0.08	1.17	1.70				
	Interno	3/8"	16	0.5-1.5	48-16	3XIRA60...	0.05	1.04	0.94				
				1.75-3.0	14-8	3XIRG60...	0.16	1.12	1.60	YI3	AVR...-3X		
				0.5-3.0	48-8	3XIRAG60...	0.05	1.28	1.60				
				1/2"	22	3.5-6.0	7-5	4XIRP60...	0.30	0.68	2.60	YI4	AVR...-4X
				1/4"	11	0.5-1.5	48-16	2XIRA60...	0.05	0.72	0.90	-	NVR...-2X

Parziale 55°

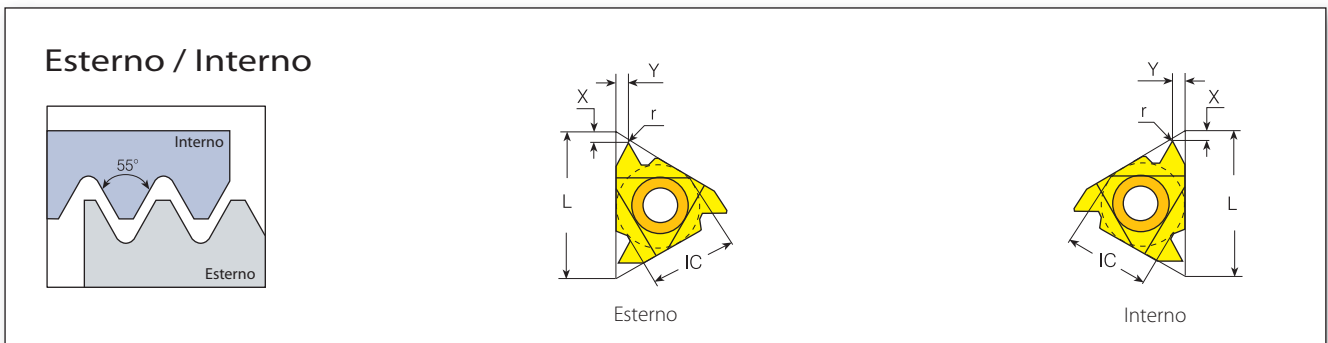

	Dim. Inserto		Passo		Codice	Dimensioni (mm)			Sottoplacchetta				
	IC	L mm	mm	tpi	RH	r	X	Y	RH	Portainseriti			
	Esterno	3/8"	16	0.5-1.5	48-16	3XERA55...	0.05	1.04	0.99				
				1.75-3.0	14-8	3XERG55...	0.21	1.10	1.65	YE3	AL...-3X		
				0.5-3.0	48-8	3XERAG55...	0.07	1.13	1.70				
	Interno	3/8"	16	0.5-1.5	48-16	3XIRA55...	0.05	1.04	0.90				
				1.75-3.0	14-8	3XIRG55...	0.21	1.12	1.65	YI3	AVR...-3X		
				0.5-3.0	48-8	3XIRAG55...	0.07	1.12	1.70				
				1/2"	22	3.5-6.0	7-4	4XIRP55...	0.43	0.25	2.75	YI4	AVR...-4X
				1/4"	11	0.5-1.5	48-16	2XIRA55...	0.05	0.72	0.90	-	NVR...-2X

ISO Metrica

Esterno / Interno

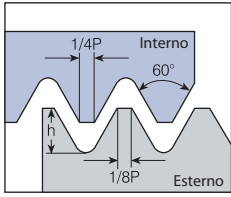

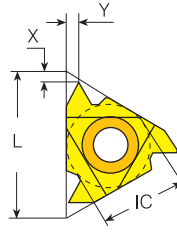

Definita da: R262(DIN 13)
Classe di tolleranza: 6g/6H

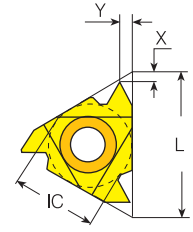

Esterno



Interno

	Dim. Inserto		Passo	Codice	Dimensioni (mm)			Sottopiacchetta	
	IC	L mm			mm	RH	h min	X	Y
 Esterno	3/8"	16	0.5	3XER0.5ISO...	0.31	1.32	0.50	YE3	AL...-3X
			0.75	3XER0.75ISO...	0.46	1.32	0.50		
			0.8	3XER0.8ISO...	0.49	1.32	0.60		
			1.0	3XER1.0ISO...	0.61	1.32	0.80		
			1.25	3XER1.25ISO...	0.77	1.32	0.80		
			1.5	3XER1.5ISO...	0.92	1.32	1.00		
			1.75	3XER1.75ISO...	1.07	1.32	1.20		
			2.0	3XER2.0ISO...	1.23	1.32	1.40		
	2.5	3XER2.5ISO...	1.53	1.32	1.40				
	1/2"	22	3.5	4XER3.5ISO...	2.15	1.67	2.40	YE4	AL...-4X
			4.0	4XER4.0ISO...	2.45	1.67	2.40		
			4.5	4XER4.5ISO...	2.76	1.67	2.35		
			5.0	4XER5.0ISO...	3.07	1.38	2.50		
			6.0	4XER6.0ISO...	3.68	0.88	2.80		
 Interno	1/4"	11	0.5	2XIR0.5ISO...	0.29	0.72	0.50	-	NVR...-2X
			0.75	2XIR0.75ISO...	0.43	0.72	0.60		
			1.0	2XIR1.0ISO...	0.58	0.72	0.85		
			1.5	2XIR1.5ISO...	0.87	0.72	0.90		
	3/8"	16	0.75	3XIR0.75ISO...	0.43	1.30	0.50	YI3	AVR...-3X
			1.0	3XIR1.0ISO...	0.58	1.30	0.80		
			1.25	3XIR1.25ISO...	0.72	1.30	0.80		
			1.5	3XIR1.5ISO...	0.87	1.30	1.00		
			1.75	3XIR1.75ISO...	1.01	1.30	1.20		
			2.0	3XIR2.0ISO...	1.15	1.30	1.40		
			2.5	3XIR2.5ISO...	1.44	1.30	1.40		
			3.0	3XIR3.0ISO...	1.73	1.30	1.80		
	1/2"	22	3.5	4XIR3.5ISO...	2.02	1.64	2.40	YI4	AVR...-4X
			4.0	4XIR4.0ISO...	2.31	1.64	2.40		
			4.5	4XIR4.5ISO...	2.60	1.64	2.40		
			5.0	4XIR5.0ISO...	2.89	1.35	2.50		
			6.0	4XIR6.0ISO...	3.46	0.87	2.40		

UN Americana

Esterno / Interno

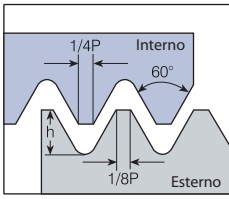

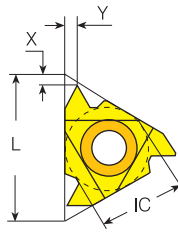

Definita da: ANSI B1.1:74
Classe di tolleranza: 2A/2B

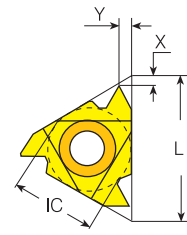

Esterno



Interno

	Dim. Inserto		Passo	Codice	Dimensioni (mm)			Sottopiacchetta		
	IC	L mm			h min	X	Y	RH	Portainseriti	
	Esterno	3/8"	16	32	3XER32UN...	0.49	1.32	0.50		
				28	3XER28UN...	0.56	1.32	0.80		
				24	3XER24UN...	0.65	1.32	0.80		
				20	3XER20UN...	0.78	1.32	0.80		
				18	3XER18UN...	0.87	1.32	1.00	YE3	AL...-3X
				16	3XER16UN...	0.97	1.32	1.00		
				14	3XER14UN...	1.11	1.32	1.20		
				13	3XER13UN...	1.20	1.32	1.40		
				12	3XER12UN...	1.30	1.32	1.40		
				8	3XER8UN...	1.95	1.32	1.45		
	Interno	1/4"	11	32	2XIR32UN...	0.46	0.72	0.60		
				28	2XIR28UN...	0.52	0.72	0.80		
				24	2XIR24UN...	0.61	0.72	0.85		
				20	2XIR20UN...	0.73	0.72	0.90	-	NVR...-2X
				18	2XIR18UN...	0.81	0.72	0.90		
				16	2XIR16UN...	0.92	0.72	0.90		
				14	2XIR14UN...	1.05	0.80	1.10		
	3/8"	16	20	3XIR20UN...	0.73	1.30	0.80			
			18	3XIR18UN...	0.81	1.30	1.00			
			16	3XIR16UN...	0.92	1.30	1.00			
			14	3XIR14UN...	1.05	1.30	1.20	YI3	AVR...-3X	
			13	3XIR13UN...	1.13	1.30	1.40			
			12	3XIR12UN...	1.22	1.30	1.40			
8	3XIR8UN...	1.83	1.30	1.40						

Whitworth per BSW, BSP, BSF, BSB

Esterno / Interno

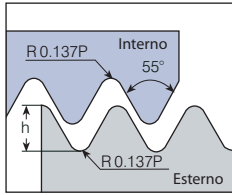

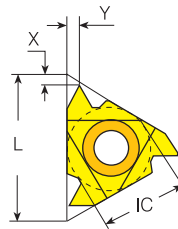

Definita da: B.S.84:1956, DIN259, ISO228/1:1982
Classe di tolleranza: Medium class A

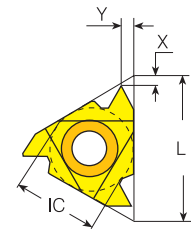

Esterno



Interno

	Dim. Inserto	Passo		Codice	Dimensioni (mm)			Sottopiacchetta	
		IC	L mm		tpi	RH	h min	X	Y
 Esterno	3/8"	16	28	3XER28W...	0.58	1.32	0.80		
			19	3XER19W...	0.86	1.32	0.80		
			16	3XER16W...	1.02	1.32	1.00	YE3	AL...-3X
			14	3XER14W...	1.16	1.32	1.40		
			11	3XER11W...	1.48	1.32	1.40		
 Interno	1/4"	11	19	2XIR19W...	0.86	0.72	0.90	-	NVR...-2X
			14	2XIR14W...	1.16	0.72	0.95		
	3/8"	16	16	3XIR16W...	1.02	1.30	1.00		
			14	3XIR14W...	1.16	1.30	1.20	YI3	AVR...-3X
			11	3XIR11W...	1.48	1.30	1.40		

BSPT

Esterno / Interno

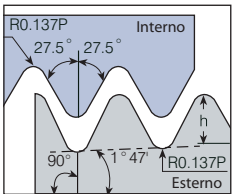

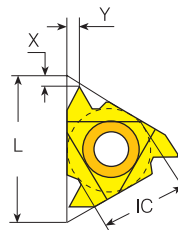

Definita da: B.S.21:1985
Classe di tolleranza: Standard BSPT

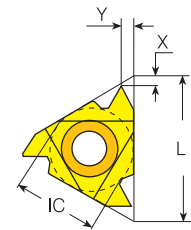

Esterno



Interno

	Dim. Inserto	Passo		Codice	Dimensioni (mm)			Sottopiacchetta	
		IC	L mm		tpi	RH	h min	X	Y
 Esterno	3/8"	16	19	3XER19BSPT...	0.86	1.32	0.80		
			14	3XER14BSPT...	1.16	1.32	1.20	YE3	AL...-3X
			11	3XER11BSPT...	1.48	1.32	1.40		
 Interno	1/4"	11	19	2XIR19BSPT...	0.86	0.72	0.85	-	NVR...-2X
			14	2XIR14BSPT...	1.16	0.72	0.95		
	3/8"	16	14	3XIR14BSPT...	1.16	1.30	1.20		
			11	3XIR11BSPT...	1.48	1.30	1.40	YI3	AVR...-3X

NPT

Esterno / Interno

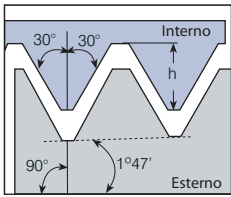

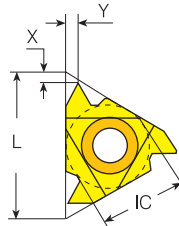

Definita da: USAS B2.1:1968
Classe di tolleranza: Standard NPT

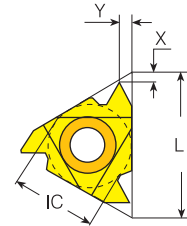

Esterno



Interno

	Dim. Inserto		Passo	Codice	Dimensioni (mm)			Sottopiacchetta	
	IC	L mm	tpi	RH	h min	X	Y	RH	Portainseriti
 Esterno	3/8"	16	27	3XER27NPT...	0.66	1.03	0.80		
			18	3XER18NPT...	1.01	1.03	1.00		
			14	3XER14NPT...	1.33	1.03	1.20	YE3	AL...-3X
			11.5	3XER11.5NPT...	1.64	1.03	1.40		
			8	3XER8NPT...	2.42	1.03	1.55		
 Interno	1/4"	11	18	2XIR18NPT...	1.01	0.72	0.85	-	NVR...-2X
			14	2XIR14NPT...	1.33	0.72	1.00		
	3/8"	16	14	3XIR14NPT...	1.33	1.01	1.20		
			11.5	3XIR11.5NPT...	1.64	1.01	1.40	YI3	AVR...-3X
			8	3XIR8NPT...	2.42	1.01	1.55		

Tondo (DIN 405)

Esterno / Interno

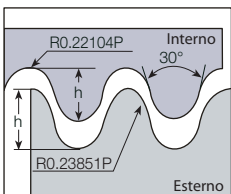

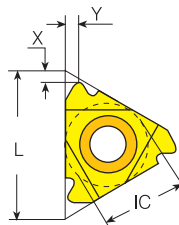

Definita da: DIN 405
Classe di tolleranza: 7h/7H

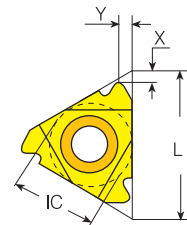

Esterno



Interno

	Dim. Inserto		Passo	Codice	Dimensioni (mm)			Sottopiacchetta	
	IC	L mm	tpi	RH	h min	X	Y	RH	Portainseriti
 Esterno	3/8"	16	6	3XER6RD...	2.12	1.43	1.60	YE3	AL...-3X
	1/2"	22	4	4XER4RD...	3.18	2.12	2.13	YE4	AL...-4X
 Interno	3/8"	16	6	3XIR6RD...	2.12	1.45	1.60	YI3	AVR...-3X
	1/2"	22	4	4XIR4RD...	3.18	2.18	2.25	YI4	AVR...-4X

Trapez

Esterno / Interno

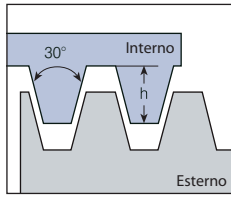

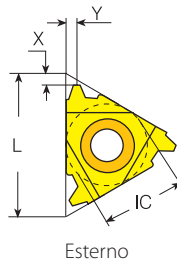

Definita da: DIN103
Classe di tolleranza: 7e/7H

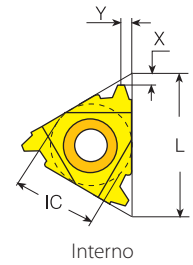

Esterno



Interno

	Dim. Inserto	Passo	Codice	Dimensioni (mm)			Sottopiacchetta		
				IC	L mm	mm	RH	h min	X
 Esterno	3/8"	16	2.0	3XER2.0TR...	1.25	1.37	1.10	YE3	AL...-3X
			3.0	3XER3.0TR...	1.75	1.27	1.30		
	1/2"	22	4.0	4XER4.0TR...	2.25	1.42	2.45	YE4	AL...-4X
			5.0	4XER5.0TR...	2.75	1.42	2.45		
			6.0	4XER6.0TR...	3.50	0.81	2.40		
 Interno	3/8"	16	2.0	3XIR2.0TR...	1.25	1.40	1.10	YI3	AVR...-3X
			3.0	3XIR3.0TR...	1.75	1.29	1.40		
	1/2"	22	4.0	4XIR4.0TR...	2.25	1.45	2.45	YI4	AVR...-4X
			5.0	4XIR5.0TR...	2.75	1.45	2.45		
			6.0	4XIR6.0TR...	3.50	0.83	2.40		

ACME American

Esterno / Interno

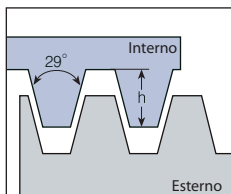

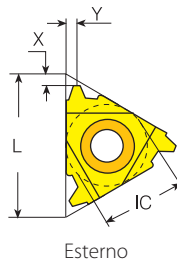

Definita da: ANSI B1.5:1988
Classe di tolleranza: 3G

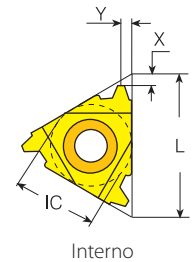

Esterno



Interno

	Dim. Inserto	Passo	Codice	Dimensioni (mm)			Sottopiacchetta		
				IC	L mm	tpi	RH	h min	X
 Esterno	3/8"	16	12	3XER12ACME...	1.19	1.33	1.20	YE3	AL...-3X
			10	3XER10ACME...	1.52	1.33	1.30		
			8	3XER8ACME...	1.84	1.50	1.30		
	1/2"	22	6	4XER6ACME...	2.37	1.37	2.50	YE4	AL...-4X
			5	4XER5ACME...	2.79	1.37	2.50		
			4	4XER4ACME...	3.43	0.76	2.40		
 Interno	3/8"	16	12	3XIR12ACME...	1.19	1.30	1.20	YI3	AVR...-3X
			10	3XIR10ACME...	1.52	1.30	1.30		
			8	3XIR8ACME...	1.84	1.20	1.25		
	1/2"	22	6	4XIR6ACME...	2.37	1.37	2.40	YI4	AVR...-4X
			5	4XIR5ACME...	2.79	1.37	2.30		
			4	4XIR4ACME...	3.43	0.76	2.40		

Stub ACME

Esterno / Interno

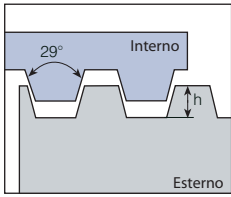

Definita da: ANSI B1.8:1988
Classe di tolleranza: 2G

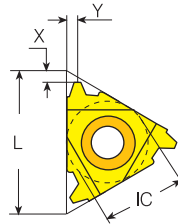

Esterno

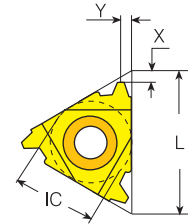

Interno

		Dim. Insetto		Passo	Codice	Dimensioni (mm)			Sottopiacchetta	
		IC	L mm	tpi	RH	h min	X	Y	RH	Portainseriti
	Esterno	3/8"	16	12	3XER12STACME...	0.76	1.33	1.10	YE3	AL...-3X
				10	3XER10STACME...	1.02	1.33	1.20		
				8	3XER8STACME...	1.21	1.14	1.15		
				6	3XER6STACME...	1.52	1.67	1.50		
	Interno	3/8"	16	12	3XIR12STACME...	0.76	1.33	1.10	YI3	AVR...-3X
				10	3XIR10STACME...	1.02	1.33	1.20		
				8	3XIR8STACME...	1.21	1.14	1.10		
				6	3XIR6STACME...	1.52	1.67	1.60		

UNJ

Esterno / Interno

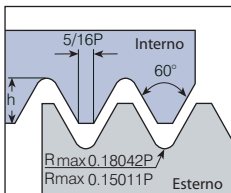

Definita da: MIL-S-8879C
Classe di tolleranza: 3A/3B

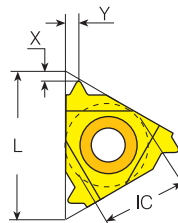

Esterno

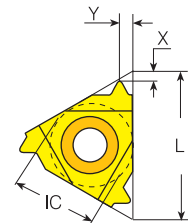

Interno

		Dim. Insetto		Passo	Codice	Dimensioni (mm)			Sottopiacchetta	
		IC	L mm	tpi	RH	h min	X	Y	RH	Portainseriti
	Esterno	3/8"	16	24	3XER24UNJ...	0.61	1.32	0.80	YE3	AL...-3X
				20	3XER20UNJ...	0.73	1.32	0.80		
				18	3XER18UNJ...	0.81	1.32	1.00		
				16	3XER16UNJ...	0.92	1.32	1.00		
				12	3XER12UNJ...	1.22	1.32	1.40		
	Interno	1/4"	11	18	2XIR18UNJ...	0.74	0.72	0.90	-	NVR...-2X
				14	2XIR14UNJ...	0.95	0.72	0.95		
		3/8"	16	16	3XIR16UNJ...	0.83	1.30	1.00	YI3	AVR...-3X
				12	3XIR12UNJ...	1.11	1.30	1.40		

American Buttress

Esterno / Interno

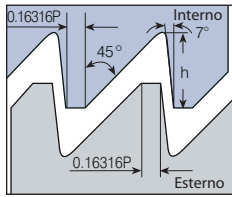

Definita da: ANSI B1.9.1973
Classe di tolleranza: CLASS 2

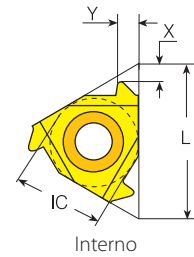
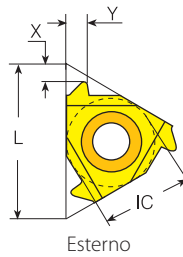

	Dim. Inserto		Passo	Codice	Dimensioni (mm)			Sottopiacchetta	
	IC	L mm	tpi	RH	h min	X	Y	RH	Portainseriti
Esterno	3/8"	16	12	3XER12ABUT...	1.40	1.40	1.40	YE3	AL...-3X



Interno	3/8"	16	12	3XIR12ABUT...	1.40	1.40	1.40	YI3	AVR...-3X
----------------	------	----	----	---------------	------	------	------	-----	-----------

API

Esterno / Interno

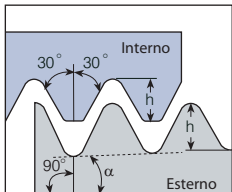

$$\alpha = \arctg (IPF/24)$$

Definita da: API SPEC. 7:1990
Classe di tolleranza: Standard API

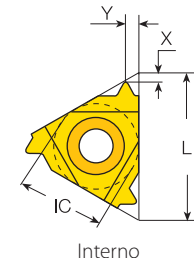
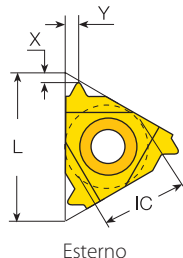

Per maggiori informazioni riguardo le dimensioni e le tolleranze standard, consultare pag. 15.



	Dim. Inserto		Passo	Fillettatura	Passo	Codice	Dimensione	Dimensioni (mm)			Sottopiacchetta	
	IC	L mm	tpi	IPF	RH		h nominale	X	Y	RH	Portainseriti	
Esterno	1/2"	22	4	V-0.038R	2	4XER4API382...	NC23-NC50	3.09	1.67	2.60		
			4	V-0.038R	3	4XER4API383...	NC56-NC77	3.08	1.67	2.70		
			4	V-0.050	2	4XER4API502...	6 5/8" REG	3.75	0.98	2.80	YE4	AL...-4X
			4	V-0.050	3	4XER4API503...	5 1/2", 7 5/8", 8 5/8" REG	3.74	0.98	2.90		
Interno	1/2"	22	4	V-0.038R	2	4XIR4API382...	NC23-NC50	3.09	1.64	2.60		
			4	V-0.038R	3	4XIR4API383...	NC56-NC77	3.08	1.64	2.70		
			4	V-0.050	2	4XIR4API502...	6 5/8" REG	3.75	0.98	2.80	YI4	AVR...-4X
			4	V-0.050	3	4XIR4API503...	5 1/2", 7 5/8", 8 5/8" REG	3.74	0.98	2.90		
			5	V-0.040	3	4XIR5API403...	2 3/8" - 4 1/2" REG	2.99	1.35	2.50		

API Buttress Casing

Esterno / Interno

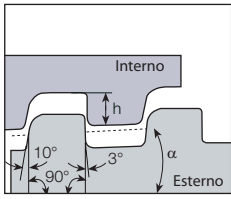

$$\alpha = \arctg (IPF/24)$$

Definita da: STD.SB.1979
Classe di tolleranza: Standard API

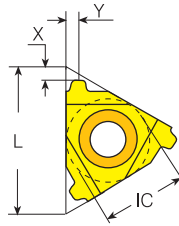

Esterno

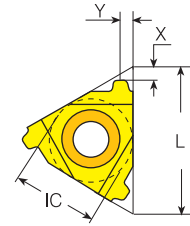

Interno

Per maggiori informazioni riguardo le dimensioni e le tolleranze standard, consultare pag. 15.



	Dim. Inserto		Passo		Codice	Dimensioni (mm)			Sottopiacchetta	
	IC	L mm	tpi	IPF	RH	h nominale	X	Y	RH	Portainseriti
	1/2"	22	5	0.75	4XER5BUT75...	1.57	1.97	2.60	YE4	AL...-4X
			5	1	4XER5BUT1...	1.57	1.97	2.41		
	1/2"	22	5	0.75	4XIR5BUT75...	1.57	1.93	2.89	YI4	AVR...-4X
			5	1	4XIR5BUT1...	1.57	1.93	2.09		

API Round Casing & Tubing

Esterno / Interno

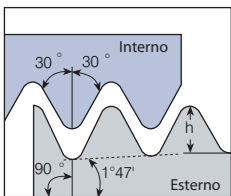

Definita da: STD. SB:1979
Classe di tolleranza: Standard API RD

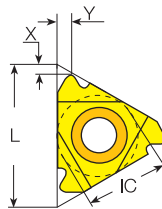

Esterno

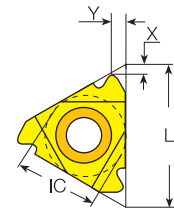

Interno

Per maggiori informazioni riguardo le dimensioni e le tolleranze standard, consultare pag. 15.

	Dim. Inserto		Passo		Codice	Dimensioni (mm)			Sottopiacchetta	
	IC	L mm	tpi	IPF	RH	h nominal	X	Y	RH	Portainseriti
	3/8"	16	10		3XER10APIRD...	1.41	1.32	1.30	YE3	AL...-3X
			8		3XER8APIRD...	1.81	1.32	1.50		
	1/2"	22	10		4XER10APIRD...	1.41	1.67	2.40	YE4	AL...-4X
			8		4XER8APIRD...	1.81	1.67	2.40		
	3/8"	16	10		3XIR10APIRD...	1.41	1.30	1.30	YI3	AVR...-3X
			8		3XIR8APIRD...	1.81	1.30	1.50		
	1/2"	22	10		4XIR10APIRD...	1.41	1.64	2.20	YI4	AVR...-4X
			8		4XIR8APIRD...	1.81	1.64	2.20		

Portainseriti per Esterni

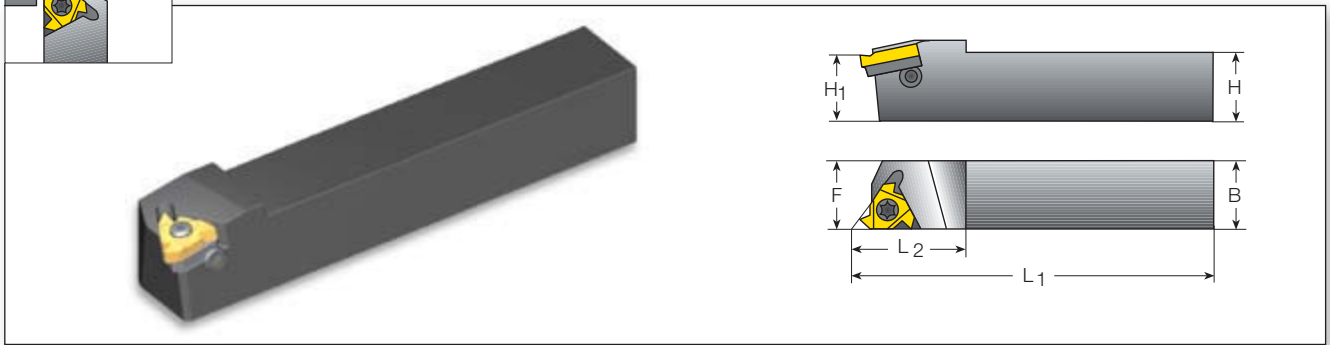

Ricambi

Dim. Inserto	Codice	Dimensioni (mm)										
		IC	RH	H=H1=B	F	L1	L2	Vite inserto	Vite sottoplac.	Chiave Torx	Sottoplac. RH	Sottoplac. LH
3/8"	AL 12-3X			12	16	83.2	22	SA3TS	SY3T	K3T	YE3	YI3
	AL 16-3X			16	16	100	20.5					
	AL 20-3X			20	20	128.6	30					
	AL 25-3X			25	25	153.6	30					
	AL 32-3X			32	32	173.6	30					
1/2"	AL 25-4X			25	25	153	31	SA4TS	SY4T	K4T	YE4	YI4
	AL 32-4X			32	32	173	34					

Portainseriti per Interni

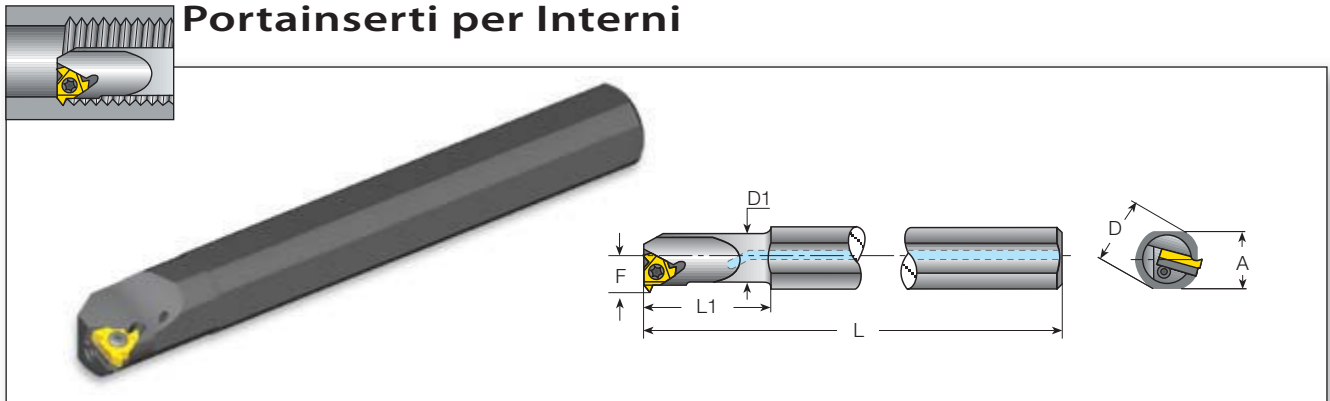

Ricambi

Dim. Inserto	Codice	Dimensioni (mm)							Diam. Min. del foro						
		IC	RH	A	L	L1	D	D1		F	mm	Vite inserto	Vite sottoplac.	Chiave Torx	Sottoplac. RH
1/4"	NVRC 10-2X			18	180	27	20	10	6.64	13	SN2TS	-	K2T	-	-
	NVRC 13-2X			18	180	33	20	13	8.17	16					
3/8"	NVRC 13-3X			18	180	32	20	12.7	10.3	17	SA3TS	SY3T	K3T	YI3	YE3
	NVRC 16-3X			18	180	40	20	16	11.5	20					
	AVRC 20-3X			18	180	40	20	20	13.4	24					
	AVRC 25-3X			29	250	60	32	25	16.3	29					
	AVRC 32-3X			29	250	60	32	32	19.6	36					
	AVRC 40-3X			36	300	60	40	40	23.8	44					
1/2"	NVRC 20-4X			18	180	51	20	19.6	13.72	26	SA4TS	SY4T	K4T	YI4	YE4
	AVRC 25-4X			28.8	250	61	32	25	15.91	32					
	AVRC 32-4X			28.8	250	51	32	31.6	19.41	38					
	AVRC 40-4X			36	300	61	40	39.7	24.01	46					

Calcolando l'angolo d'elica β

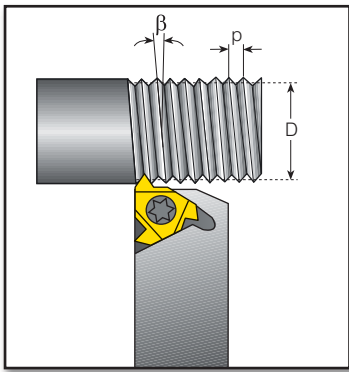

L'angolo d'elica è calcolato con la seguente formula

$$\beta = \arctan \frac{P \times N}{\pi \times D}$$

β - Angolo dell'elica [°]
 P - Passo [mm]
 N - No. di principi [mm]
 D - Diametro del passo [mm]
 Passover = P x N

L'angolo dell'elica può anche essere determinato dal diagramma sottostante

Diagramma dell'angolo d'elica

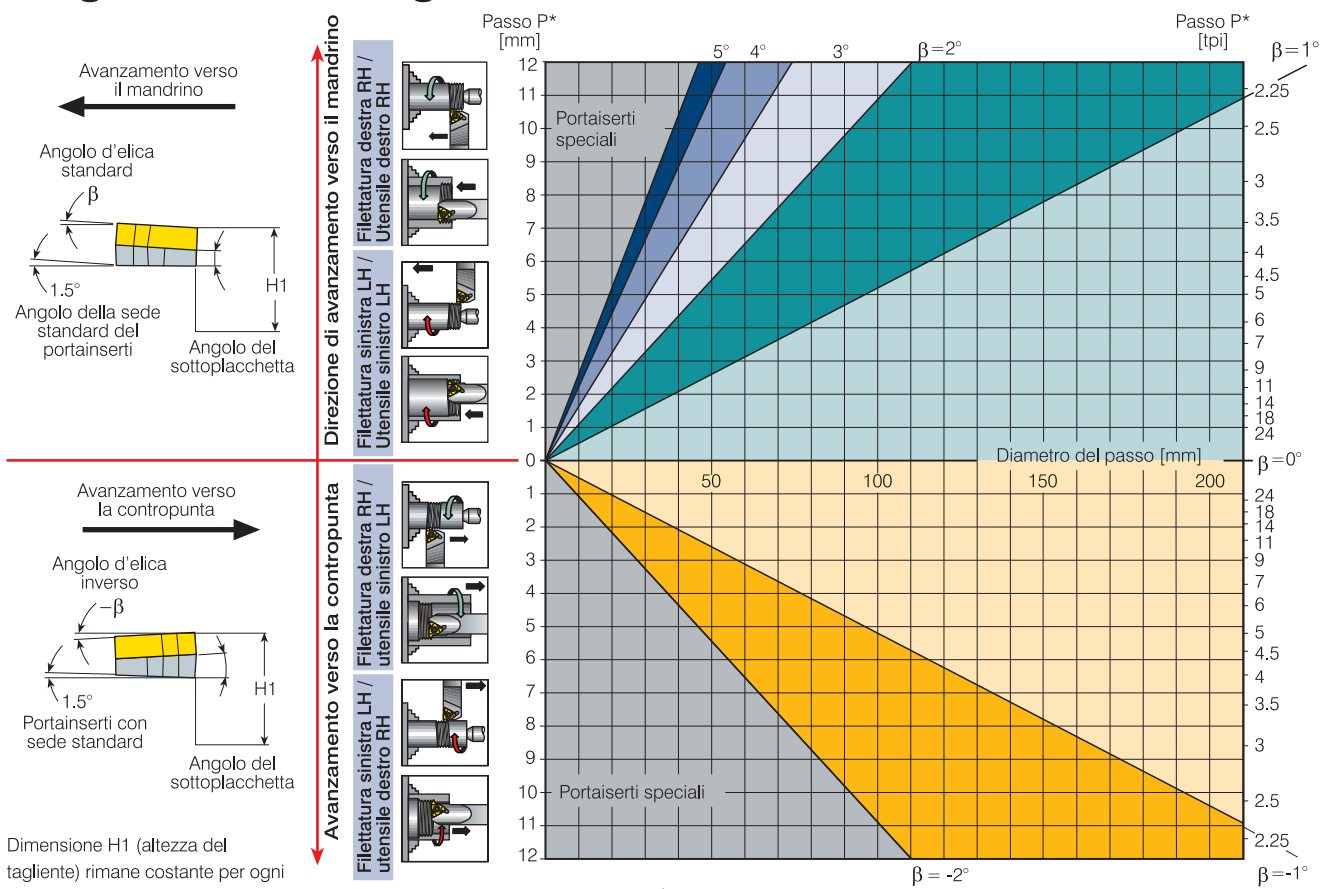

* Per filettature a più principi utilizzare il valore del passo reale invece del passo apparente

Sottoplacchetta

Risultante dell'angolo d'elica		4.5°	3.5°	2.5°	1.5°	0.5°	0°	-0.5°	-1.5°	
Grandezza inserto	Portaiserti	Codice								
IC	L mm									
3/8"	16	ER / IL	YE3-3P	YE3-2P	YE3-1P	YE3	YE3-1N	YE3-1.5N	YE3-2N	YE3-3N
		EL / IR	YI3-3P	YI3-2P	YI3-1P	YI3	YI3-1N	YI3-1.5N	YI3-2N	YI3-3N
1/2"	22	ER / IL	YE4-3P	YE4-2P	YE4-1P	YE4	YE4-1N	YE4-1.5N	YE4-2N	YE4-3N
		EL / IR	YI4-3P	YI4-2P	YI4-1P	YI4	YI4-1N	YI4-1.5N	YI4-2N	YI4-3N

API Disegno Standard

API

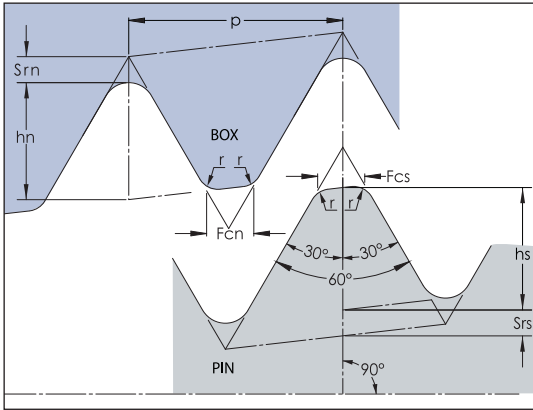

Forma del filettatura	IPF	Altezza troncadel profilo $h_s = h_n$	Troncatura del fondo $S_{rn} = S_{rs}$	Altezza del piano $F_{cn} = F_{cs}$	Raggio sugli spigoli della filettatura (r)	Passo (TPI)
V 0.038R	2	+ 0.03 - 0.08 3.09	+ 0.03 - 0.03 0.96	+ 0.05 1.65	+ 0.05 - 0.05 0.38	4
V 0.038R	3	+ 0.03 - 0.08 3.08	+ 0.03 - 0.03 0.96	+ 0.05 1.65	+ 0.05 - 0.05 0.38	4
V0.040	3	+ 0.03 - 0.08 2.99	+ 0.03 - 0.03 0.51	+ 0.05 1.02	+ 0.05 - 0.05 0.38	5
V0.050	2	+ 0.03 - 0.08 3.75	+ 0.03 - 0.03 0.63	+ 0.05 1.27	+ 0.05 - 0.05 0.38	4
V0.050	3	+ 0.03 - 0.08 3.74	+ 0.03 - 0.03 0.63	+ 0.05 1.27	+ 0.05 - 0.05 0.38	4

API Round Casing & Tubing

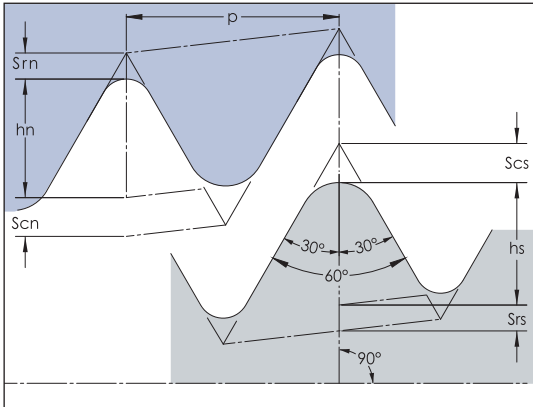

Dati della filettatura	8 TPI	10 TPI
$h_s = h_n$	+0.05 - 0.10 1.81	+0.05 - 0.10 1.41
$S_{rn} = S_{rs}$	0.43	0.36
$S_{cs} = S_{cn}$	0.51	0.43

API Buttress Casing

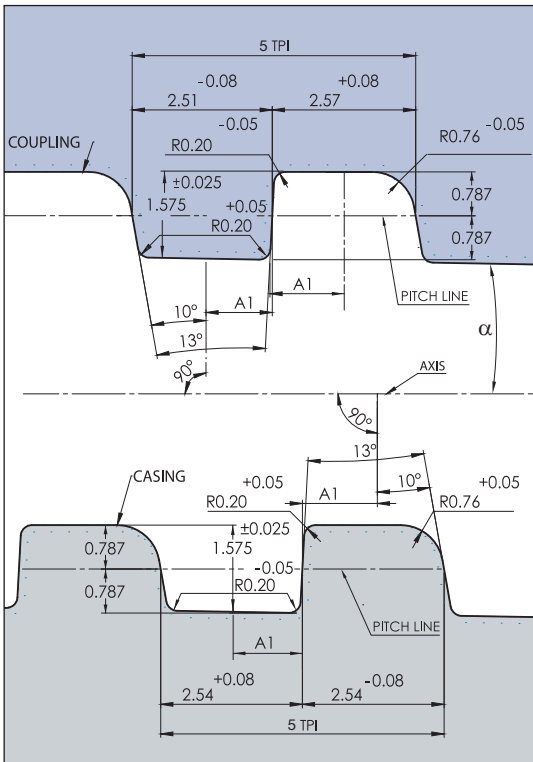

Conicità	A1, mm	α	Altezza profilo
0.75	-	$1^\circ 47' 24''$	± 0.025
1	1.27	$2^\circ 23' 17''$	1.575

Gradi di metallo duro e parametri di lavoro consigliati Vc [m/min]

Gruppi materiali	Vardex N°	Materiale	Durezza Brinell HB	Vc [m/min]	
					Rivestito VKX
P Acciai	1	Acciaio non legato	Basso carbonio (C=0.1-0.25%)	125	115-190
	2		Medio carbonio (C=0.25-0.55%)	150	100-175
	3		Alto carbonio (C=0.55-0.85%)	170	90-165
	4	Bassamente legato (elementi leganti ≤5%)	Non temprato	180	100-180
	5		Temprato	275	75-140
	6		Temprato	350	70-135
	7	Acciaio altamente legato (elementi leganti >5%)	Ricotto	200	80-120
	8		Temprato	325	50-100
	9	Acciaio fuso	Bassamente legato (elementi leganti <5%)	200	70-130
	10		Altamente legato (elementi leganti >5%)	225	60-120
M Acciai Inossidabili	11	Acciaio inossidabile Ferritico	Non temprato	200	70-130
	12		Temprato	330	60-115
	13	Acciaio inossidabile Austenitico	Austenitico	180	90-140
	14		Superaustenitico	200	40-110
	15	Acciaio inossidabile Fuso Ferritico	Non temprato	200	90-120
	16		Temprato	330	65-110
	17	Acciaio inossidabile fuso Austenitico	Austenitico	200	85-110
	18		Temprato	330	60-100
K Ghise	28	Ghisa malleabile	Ferritico (truciolo corto)	130	60-70
	29		Perlitico (truciolo lungo)	230	60-145
	30	Ghisa grigia	Bassa resistenza alla trazione	180	70-130
	31		Alta resistenza alla trazione	260	60-115
	32	Ghisa nodulare SG	Ferritico	160	125-160
	33		Perlitico	260	90-120
N(K) Metalli non ferrosi	34	Leghe di alluminio Saldate	Non invecchiato	60	100-365
	35		Ricotto	100	80-220
	36	Leghe di alluminio	Fuso	75	200-400
	37		Fuso & Ricotto	90	200-280
	38	Leghe di alluminio	Fuso Si 13-22%	130	60-180
	39	Rame e leghe di rame	Ottone	90	80-225
	40		Bronzo and Rame senza piombo	100	80-255
S(M) Materiali resistenti al calore	19	Leghe ad alta temperatura	Ricotto (Base ferro)	200	45-60
	20		Incrudito (Base ferro)	280	30-50
	21		Ricotto (Base Nichel o cobalto)	250	20-30
	22		Incrudito (Base Nichel o cobalto)	350	15-25
	23	Leghe di Titanio	Titanio Puro 99.5	400Rm	140-170
24	Leghe α+β		1050Rm	50-70	
H(K) Materiali temprati	25	Acciaio extra duro	Cementato & Temprato	45-50HRc	45-60
	26			51-55HRc	40-50

Calcolo del numero di giri al minuto

$$N = \frac{1000 \times V_C}{\pi \times D}$$

$$V_C = \frac{N \times \pi \times D}{1000}$$

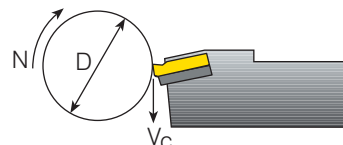

N - Numero di giri al minuto [giri/min]

Vc - Velocità di taglio [m/min]

D - Diametro del pezzo [mm]

Grado:

VKX



VKX - Il miglior grado, eccellente su acciai normali ed inossidabili. Rivestimento TiN.

Numero di passate

Passo	mm	0.50	0.75	1.00	1.25	1.50	1.75	2.00	2.50	3.00	3.50	4.00	4.50	5.00	5.50	6.00
	fil/pol.	48	32	24	20	16	14	12	10	8	7	6	5.5	5	4.5	4
Numero di passate		4-6	4-7	4-8	5-9	6-10	7-12	7-12	8-14	9-16	10-18	11-18	11-19	12-20	12-20	12-20