

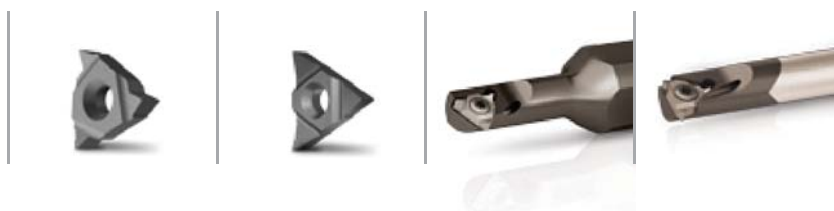

Mini-3 IC 5.0

Indexable Threading Inserts for Small Bores



METRIC

Mini-3 IC 5.0

INSERTS

■ Partial Profile 60°	Page 3
■ Partial Profile 55°	Page 3
■ ISO Metric	Page 4
■ American UN	Page 5
■ Whitworth	Page 6
■ BSPT	Page 6
■ NPT	Page 7
■ NPTF	Page 7
■ Trapez	Page 8
■ American ACME	Page 8
■ Stub ACME	Page 9
■ PG	Page 9

TOOLHOLDERS

■ Internal Toolholders - Standard	Page 10
■ Internal Toolholders - U Style	Page 10

TECHNICAL DATA

■ Recommended Grades and Cutting Speeds	Page 11
---	---------



VARGUS GENiUS™ | Tool Selector and CNC Program Generator

The most popular and advanced thread turning and thread milling software on the market today.

Now available in 3 versions at www.vargus.com:

VARGUS
GENiUS™
ONLINE

VARGUS
GENiUS™
DESKTOP

VARGUS
GENiUS™
setup.exe

Partial Profile 60°

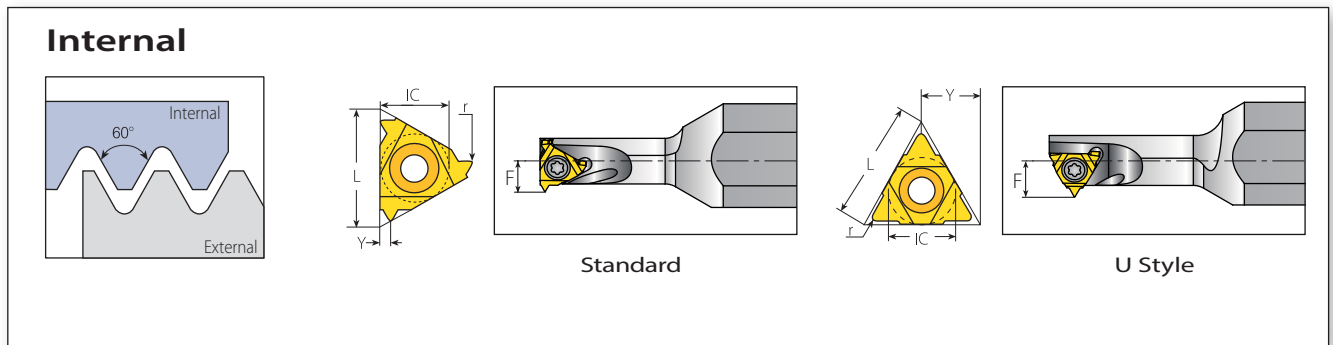

Mini-3 Standard



Insert Size		Pitch		Ordering Code		Dimensions mm			Min. Bore dia.	
IC mm	L mm	mm	tpi	RH	LH	r	Y	F	mm	Toolholder
5.0	8	0.5-1.5	48-16	5.0KIRA60...	5.0KILA60...	0.05	0.7	4.7	7.8	(C)NVRC 7-5.0K

Mini-3 U Style



Insert Size		Pitch		Ordering Code	Dimensions mm			Min. Bore dia.	
IC mm	L mm	mm	tpi	RH+LH	r	Y	F	mm	Toolholder
5.0U	8	1.75-2.0	14-11	5.0KUIB60...	0.16	4.0	5.8	9.0	(C)NVRC 8-5.0KU

Partial Profile 55°

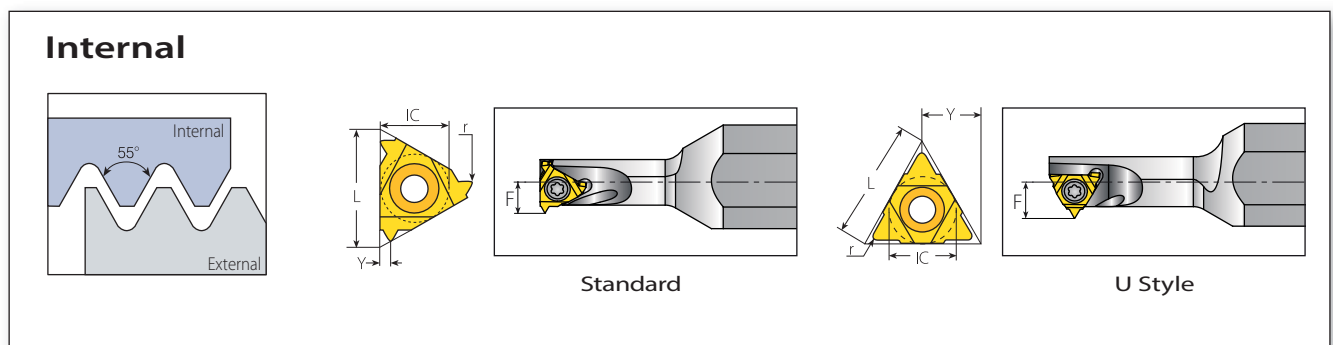

Mini-3 Standard



Insert Size		Pitch		Ordering Code		Dimensions mm			Min. Bore dia.	
IC mm	L mm	mm	tpi	RH	LH	r	Y	F	mm	Toolholder
5.0	8	0.5-1.5	48-16	5.0KIRA55...	5.0KILA55...	0.05	0.7	4.7	7.8	(C)NVRC 7-5.0K

Mini-3 U Style



Insert Size		Pitch		Ordering Code	Dimensions mm			Min. Bore dia.	
IC mm	L mm	mm	tpi	RH+LH	r	Y	F	mm	Toolholder
5.0U	8	1.75-2.0	14-11	5.0KUIB55...	0.21	4.0	5.7	9.0	(C)NVRC 8-5.0KU

ISO Metric

Internal

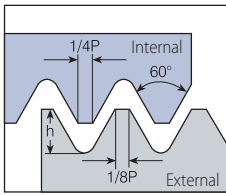

Defined by: R262 (DIN 13)
Tolerance class: 6g/gH

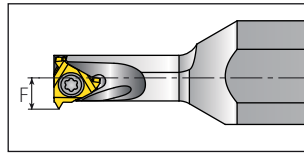
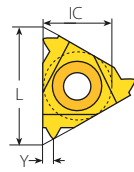

Standard

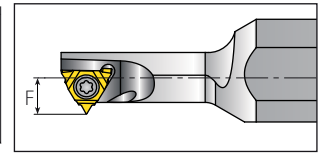
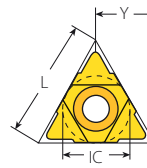

U Style

Mini-3 Standard



Insert Size		Pitch	Ordering Code		Dimensions mm			Min. Bore dia.		Toolholder
IC mm	L mm	mm	RH	LH	h min	Y	F	mm		
5.0	8	0.5	5.0KIR0.5ISO...	5.0KIL0.5ISO...	0.29	0.5	4.7	7.8	(C)NVRC 7-5.0K	
		0.75	5.0KIR0.75ISO...	5.0KIL0.75ISO...	0.43	0.5				
		1.0	5.0KIR1.0ISO...	5.0KIL1.0ISO...	0.58	0.6				
		1.25	5.0KIR1.25ISO...	5.0KIL1.25ISO...	0.72	0.7				
		1.5	5.0KIR1.5ISO...	5.0KIL1.5ISO...	0.87	0.7				
		1.75	5.0KIR1.75ISO...	5.0KIL1.75ISO...	1.01	0.8				

Mini-3 U Style



Insert Size		Pitch	Ordering Code		Dimensions mm			Min. Bore dia.		Toolholder
IC mm	L mm	mm	RH+LH	h min	Y	F	mm			
5.0U	8	2	5.0KUI2.0ISO...		1.23	4.0	5.7	9.0	(C)NVRC 8-5.0KU	

American UN

Internal

Defined by: ANSI B1.1:74
Tolerance class: 2A/2B

Standard **U Style**

Mini-3 Standard



Insert Size		Pitch	Ordering Code		Dimensions mm			Min. Bore dia.	
IC mm	L mm	tpi	RH	LH	h min	Y	F	mm	Toolholder
5.0	8	32	5.0KIR32UN...	5.0KIL32UN...	0.46	0.5	4.7	7.8	(C)NVRC 7-5.0K
		28	5.0KIR28UN...	5.0KIL28UN...	0.52	0.6			
		24	5.0KIR24UN...	5.0KIL24UN...	0.61	0.6			
		20	5.0KIR20UN...	5.0KIL20UN...	0.73	0.7			
		18	5.0KIR18UN...	5.0KIL18UN...	0.81	0.7			
		16	5.0KIR16UN...	5.0KIL16UN...	0.92	0.7			
		14	5.0KIR14UN...	5.0KIL14UN...	1.05	0.8			

Mini-3 U Style



Insert Size		Pitch	Ordering Code		Dimensions mm			Min. Bore dia.	
IC mm	L mm	tpi	RH+LH	h min	Y	F	mm	Toolholder	
5.0U	8	13	5.0KUI13UN...	1.2	4.0	5.6	9.0	(C)NVRC 8-5.0KU	
		12	5.0KUI12UN...	1.3		5.7			
		11	5.0KUI11UN...	1.42		5.7			

Whitworth - BSW, BSP (G), BSF, BSB

Internal

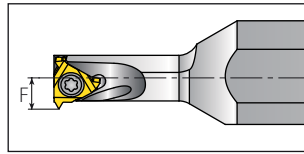
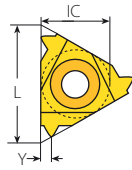
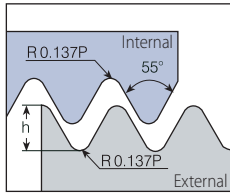

Standard

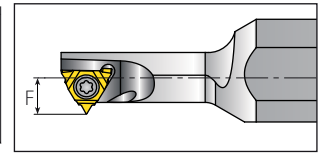
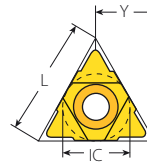

U Style

Defined by: B.S.84:1956, DIN 259, ISO228/1:1982
Tolerance class: Medium class A

Mini-3 Standard



Insert Size		Pitch	Ordering Code		Dimensions mm			Min. Bore dia.		Toolholder
IC mm	L mm	tpi	RH	LH	h min	Y	F	mm		
5.0	8	28	5.0KIR28W...	5.0KIL28W...	0.58	0.6	4.7	7.8	(C)NVRC 7-5.0K	
		24	5.0KIR24W...	5.0KIL24W...	0.68	0.6				
		20	5.0KIR20W...	5.0KIL20W...	0.81	0.7				
		19	5.0KIR19W...	5.0KIL19W...	0.86	0.7				
		18	5.0KIR18W...	5.0KIL18W...	0.90	0.7				
		16	5.0KIR16W...	5.0KIL16W...	1.02	0.7				

Mini-3 U Style



Insert Size		Pitch	Ordering Code		Dimensions mm			Min. Bore dia.		Toolholder
IC mm	L mm	tpi	RH+LH	h min	Y	F	mm			
5.0U	8	14	5.0KUI14W...	1.16	4.0	5.6	9.0	(C)NVRC 8-5.0KU		
		12	5.0KUI12W...	1.36		5.7				
		11	5.0KUI11W...	1.48		5.7				

BSPT

Internal

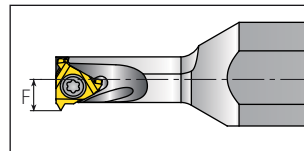
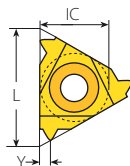
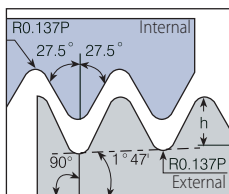

Standard

Defined by: B.S. 21:1985
Tolerance class: Standard BSPT

Mini-3 Standard



Insert Size		Pitch	Ordering Code		Dimensions mm			Min. Bore dia.		Toolholder
IC mm	L mm	tpi	RH	LH	h min	Y	F	mm		
5.0	8	28	5.0KIR28BSPT...	5.0KIL28BSPT...	0.58	0.6	4.7	7.8	(C)NVRC 7-5.0K	
		19	5.0KIR19BSPT...	5.0KIL19BSPT...	0.86	0.7				

NPT

Internal

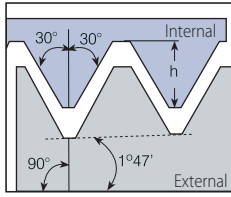

Defined by: USAS B2.1:1968
Tolerance class: Standard NPT

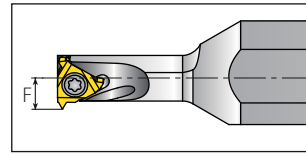
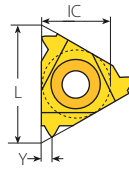

Standard

Mini-3 Standard



Insert Size		Pitch	Ordering Code		Dimensions mm		Min. Bore dia.		
IC mm	L mm	tpi	RH	LH	h min	Y	F	mm	Toolholder
5.0	8	27	5.0KIR27NPT...	5.0KIL27NPT...	0.66	0.6	4.7	7.8	(C)NVRC 7-5.0K
		18	5.0KIR18NPT...	5.0KIL18NPT...	1.01	0.8			

NPTF

Internal

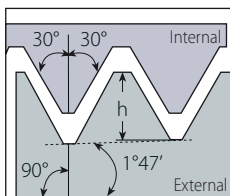

Defined by: ANSI B1.20.3-1976
Tolerance class: Class 2

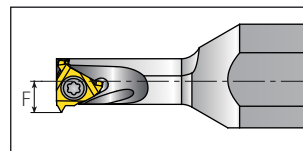
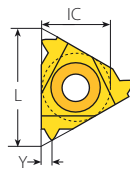

Standard

Mini-3 Standard



Insert Size		Pitch	Ordering Code		Dimensions mm		Min. Bore dia.		
IC mm	L mm	tpi	RH	LH	h min	Y	F	mm	Toolholder
5.0	8	27	5.0KIR27NPTF...	5.0KIL27NPTF...	0.64	0.6	4.7	7.8	(C)NVRC 7-5.0K
		18	5.0KIR18NPTF...	5.0KIL18NPTF...	1.00	0.8			

Trapez

Internal

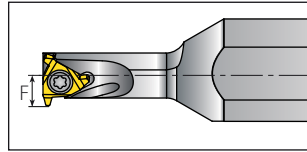
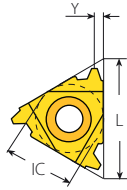
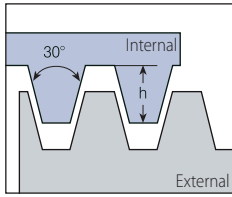

Standard

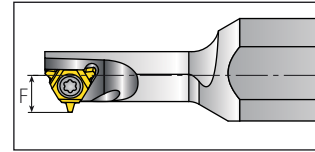
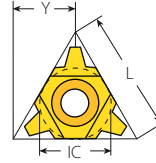

U Style

Defined by: B.S.84:1956, DIN 103
Tolerance class: 7e/7H

Mini-3 Standard



Insert Size		Pitch	Ordering Code		Dimensions mm			Min. Bore dia.	
IC mm	L mm	mm	RH	LH	h min	Y	F	mm	Toolholder
5.0	8	1.5	5.0KIR1.5TR...	5.0KIL1.5TR...	0.85	0.7	4.7	7.8	(C)NVRC 7-5.0K

Mini-3 U Style



Insert Size		Pitch	Ordering Code		Dimensions mm			Min. Bore dia.	
IC mm	L mm	mm	RH+LH	h min	Y	F	mm	Toolholder	
5.0U	8	2.0	5.0KUI2TR...	1.25	4.0	5.7	9.0	(C)NVRC 8-5.0KU	

American ACME

Internal

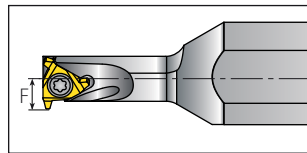
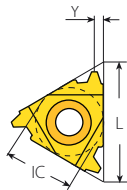
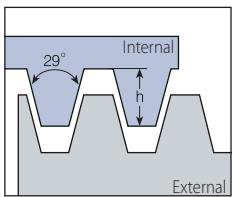

Standard

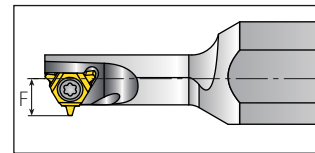
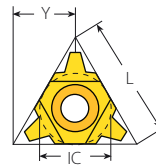

U Style

Defined by: ANSI B1.5:1988
Tolerance class: 3G

Mini-3 Standard



Insert Size		Pitch	Ordering Code		Dimensions mm			Min. Bore dia.	
IC mm	L mm	tpi	RH	LH	h min	Y	F	mm	Toolholder
5.0	8	16	5.0KIR16ACME...	5.0KIL16ACME...	0.92	0.7	4.7	7.8	(C)NVRC 7-5.0K

Mini-3 U Style



Insert Size		Pitch	Ordering Code		Dimensions mm			Min. Bore dia.	
IC mm	L mm	tpi	RH+LH	h min	Y	F	mm	Toolholder	
5.0U	8	14	5.0KUI14ACME...	1.03	4.0	5.8	9.0	(C)NVRC 8-5.0KU	
		12	5.0KUI12ACME...	1.19					
		10	5.0KUI10ACME...	1.52					

Stub ACME

Internal

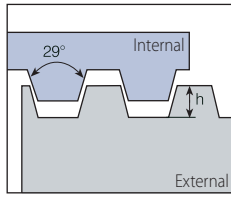

Defined by: ANSI B1.8:1988
Tolerance class: 2G

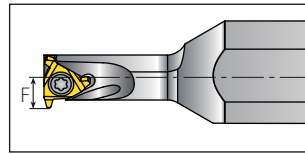
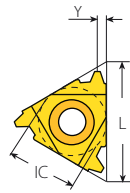

Standard

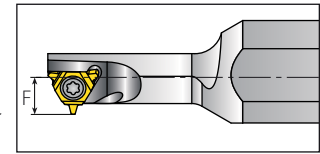
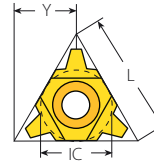

U Style

Mini-3 Standard



Insert Size		Pitch	Ordering Code		Dimensions mm			Min. Bore dia.	
IC mm	L mm	tpi	RH	LH	h min	Y	F	mm	Toolholder
5.0	8	16	5.0KIR16STACME...	5.0KIL16STACME...	0.6	0.7	4.7	7.8	(C)NVRC 7-5.0K

Mini-3 U Style



Insert Size		Pitch	Ordering Code		Dimensions mm			Min. Bore dia.	
IC mm	L mm	tpi	RH+LH	h min	Y	F	mm	Toolholder	
5.0U	8	14	5.0KUI14STACME...	0.67	4.0	5.8	9.0	(C)NVRC 8-5.0KU	
		12	5.0KUI12STACME...	0.76		5.7			
		10	5.0KUI10STACME...	1.02		5.6			

PG

Internal

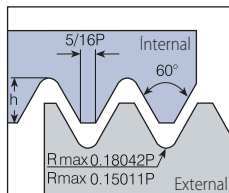

Defined by: MIL-S-8879C
Tolerance class: 3A/3B

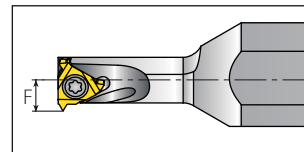
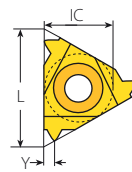

Standard

Mini-3 Standard



Insert Size		Pitch	Ordering Code		Dimensions mm			Min. Bore dia.	
IC mm	L mm	tpi	RH	LH	h min	Y	F	mm	Toolholder
5.0	8	20	5.0KIR20PG...	5.0KIL20PG...	0.61	0.7	4.7	7.8	(C)NVRC 7-5.0K

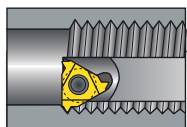

Internal Toolholders Standard

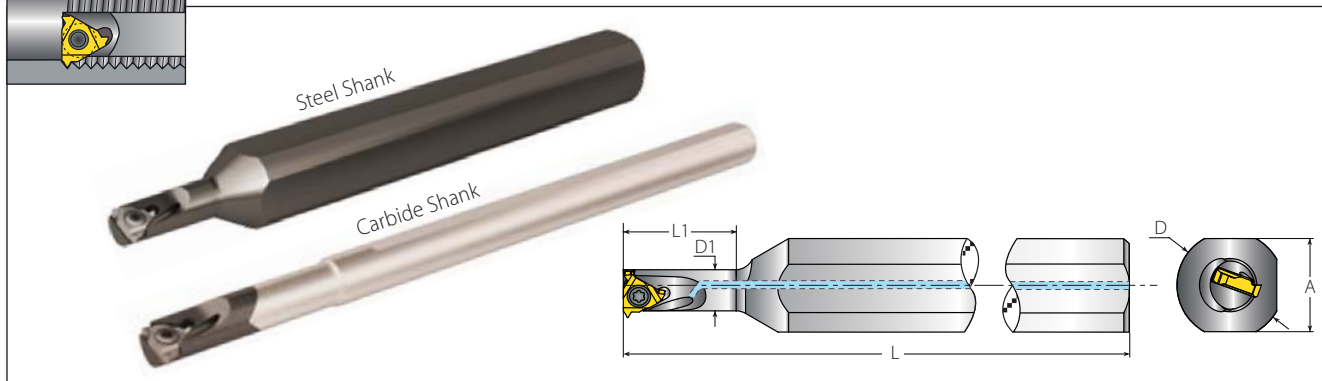

Mini-3 Standard

Insert Size		Ordering Code	Dimensions mm				Anti-Vibration System	Spare Parts	
IC mm	RH/LH	A	L	L1	D	D1		Insert Screw	Torx Key
5.0	NVRC 7-5.0K	15	125	18	16	6.6	No	SN5MT	K6MT
	CNVRC 7-5.0K	7	125	31	8	6.6	Carbide Shank		

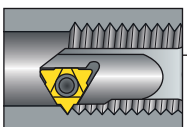

Internal Toolholders U Style

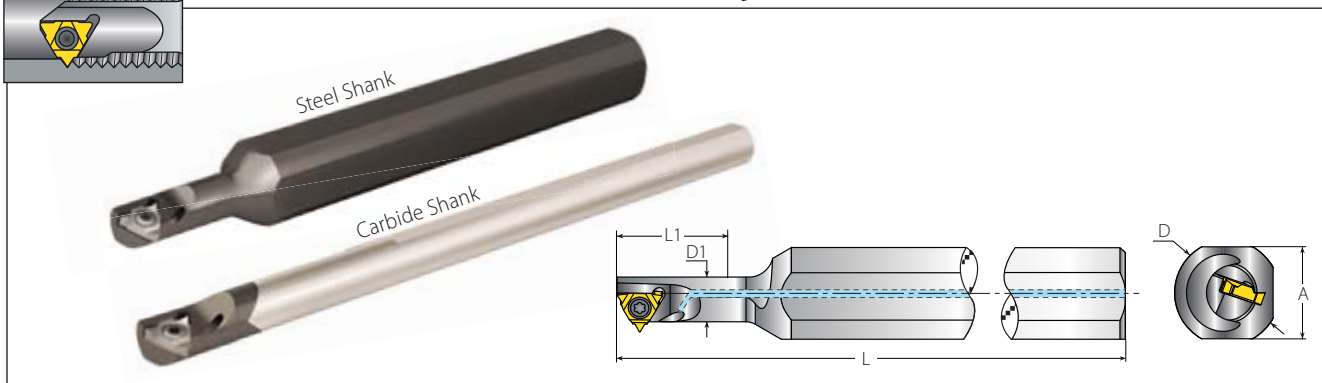

Mini-3 U Style

Insert Size		Ordering Code	Dimensions mm				Anti-Vibration System	Spare Parts	
IC mm	RH/LH	A	L	L1	D	D1		Insert Screw	Torx Key
5.0U	NVRC 8-5.0KU	15	125	21	16	7.3	No	SN5MT	K6MT
	CNVRC 8-5.0KU	7	125	35	8	7.3	Carbide Shank		

Recommended Grades and Cutting Speeds Vc [m/min] Mini-3 IC 5.0

Material Group	Vardex No.	Material	Hardness Brinell HB	Vc [m/min]	
				Coated	VBX / VTX
P Steel	1	Unalloyed steel	Low carbon (C=0.1-0.25%)	125	40-80
	2		Medium carbon (C=0.25-0.55%)	150	40-80
	3		High Carbon (C=0.55-0.85%)	170	40-80
	4	Low alloy steel (alloying elements ≤5%)	Non hardened	180	40-80
	5		Hardened	275	40-80
	6		Hardened	350	40-80
	7	High alloy steel (alloying elements >5%)	Annealed	200	40-60
	8		Hardened	325	40-60
	9	Cast steel	Low alloy (alloying elements <5%)	200	40-60
	10		High alloy (alloying elements >5%)	225	40-60
M Stainless Steel	11	Stainless steel Ferritic	Non hardened	200	40-60
	12		Hardened	330	40-60
	13	Stainless steel Austenitic	Austenitic	180	40-60
	14		Super Austenitic	200	40-60
	15	Stainless steel Cast Ferritic	Non hardened	200	40-60
	16		Hardened	330	40-60
	17	Stainless steel Cast austenitic	Austenitic	200	40-60
	18		Hardened	330	40-60
K Cast Iron	28	Malleable Cast iron	Ferritic (short chips)	130	40-80
	29		Pearlitic (long chips)	230	40-80
	30	Grey cast iron	Low tensile strength	180	40-80
	31		High tensile strength	260	40-80
	32	Nodular SG iron	Ferritic	160	40-80
	33		Pearlitic	260	40-80
N(K) Non-Ferrous Metals	34	Aluminium alloys Wrought	Non aging	60	40-120
	35		Aged	100	40-120
	36	Aluminium alloys	Cast	75	40-120
	37		Cast & aged	90	40-120
	38	Aluminium alloys	Cast Si 13-22%	130	40-120
	39	Copper and copper alloys	Brass	90	40-120
	40		Bronze and non leaded copper	100	40-120
S(M) Heat Resistant Material	19	High temperature alloys	Annealed (Iron based)	200	
	20		Aged (Iron based)	280	
	21		Annealed (Nickel or Cobalt based)	250	
	22		Aged (Nickel or Cobalt based)	350	
	23	Titanium alloys	Pure 99.5 Ti	400Rm	
	24		α+β alloys	1050Rm	
H(K) Hardened Material	25	Extra hard steel	Hardened & tempered	45-50HRc	
	26			51-55HRc	

Grades

Grade	Application
VBX	Carbide grade for Mini IC 5.0. For machining steel and general use. TiCN coated.
VTX	Carbide grade for Mini IC 5.0. For machining stainless steel and general use. TiAlN coated.

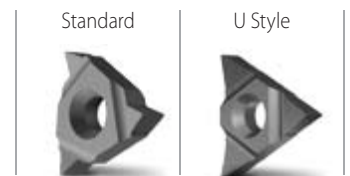

Number of Passes

Pitch	mm	0.50	0.75	1.00	1.25	1.50	1.75	2.00
	tpi	48	32	24	20	16	14	12
No. of Passes		8-13	13-18	18-23	23-28	27-32	30-35	35-40



VARDEx
Advanced Threading Solutions

Mini-3 IC 5.0
Indexable Threading Inserts for Small Bores



Visit [VARGUS](http://VARGUS.com)